

VERTICAL INCANDESCENT OPEN

4"

Open Reflector

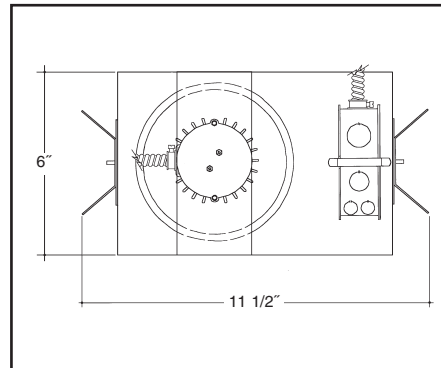
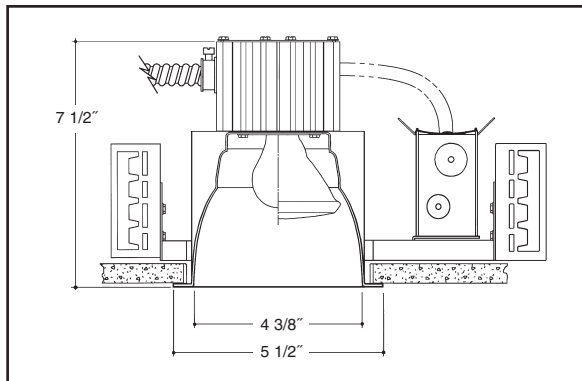

Product Information

Aluminum heatsink socket enclosure for heat dissipation.

Thermally protected fixture.

Prewired and grounded electrogalvanized, plated heavy gauge steel junction box.

Listed for through branch circuit wiring with galvanized snap on covers.

Electrogalvanized plated steel frame, spring steel adjustable roto clips for quick Reflector Kit installation.

Universal mounting brackets and hanger bars included will also accept caddy bar# 520, or C channel.

Electrogalvanized plated steel hanger bars included, extendible to 18".

Precision spun heavy aluminum Reflector anodized with standard white self flange.

Insulation must be kept 3" away from fixture. Listed for damp locations.

Listed for wet location under covered ceiling. Tested and Listed to ETL/UL standard 1598 and CSA standards.



1 Lamp Frame in Kit

Part #

A4500IN - 100 Watt Max.

Compatible Lamp Types

50W A19/A21; 75W A19/A21; 75W BR40; 100W A19
50W Par 16; 75W Par 16; 50W Par 20

For Par Lamp Add A – P to the Frame in Kit Number

ceiling 1.25"
thick

TYPE D1

Reflector Kits

Part #	Description
A4510CL	- Specular Clear "Alzak"
A4510GO	- Specular Gold "Alzak"
A4510BL	- Specular Black "Alzak"
A4510PT	- Specular Pewter "Alzak"
A4510WT	- Specular Wheat "Alzak"
A4510WH	- Matte White w/ White Flange

Other Reflector Options see page 2

Options

Suffix Specification:

- FS** - Fusing (*Slow blow fuse and holder*)
- PF** - Polish Flange
- IF** - Iridescent Free Reflector Finish
- #517** - 27" Steel Hanger Bars

Other Options see page 1